

OMRON

CV/CVM1
Replacement Guide
From CV/CVM1 to CJ2

About this document

This document provides the reference information for replacing CV/CVM1 PLC systems with CJ2 series PLC.

This document does not include precautions and reminders ;please read and understand the important precautions and reminders described on the manuals of PLCs (both of PLC used in the existing system and PLC you will use to replace the existing PLC) before attempting to start operation.

Related Manuals

CPU Units

Man.No.	Model	Manual
W472	CJ2H-CPU6□-EIP CJ2H-CPU6□ CJ2-CPU□□	CJ2 CPU Unit Hardware USER'S MANUAL
W473	CJ2H-CPU6□-EIP CJ2H-CPU6□ CJ2M-CPU□□	CJ2 CPU Unit Software USER'S MANUAL
W486	CJ2M-CPU□□+CH2M-MD21□	CJ2M Pulse I/O Module USER'S MANUAL
W394	CS1G/H-CPU□□-EV1 CS1G/H-CPU□□H CS1D-CPU□□H CS1D-CPU□□S CJ1H-CPU□□H-R CJ1G-CPU□□ CJ1G/H-CPU□□H CJ1G-CPU□□P CJ1M-CPU□□	CS/CJ/NSJ Series PROGRAMMING MANUAL
W474	CS1G/H-CPU□□H CS1G/H-CPU□□-V1 CS1D-CPU□□H CS1D-CPU□□S CJ1H-CPU□□H-R CJ1G/H-CPU□□H CJ1G-CPU□□P CJ1M/G-CPU□□ NSJ□-□□□□(B)-□□□	CS/CJ/NSJ Series INSTRUCTIONS REFERENCE MANUAL
W342	CS1G/H-CPU□□H CS1G/H-CPU□□-V1 CS1D-CPU□□H CS1D-CPU□□S CS1W-SCU□□-V1 CS1W-SCB□□-V1 CJ1H-CPU□□H-R CJ1G/H-CPU□□H CJ1G-CPU□□P CJ1M/G-CPU□□ CJ1W-SCU□□-V1 CP1H-X□□□□-□ CP1H-XA□□□□-□ CP1H-Y□□□□-□ NSJ□-□□□□(B)-□□□	CS/CJ/CP/NSJ Series Communications Commands REFERENCE MANUAL
W202	CVM1 CV500/CV1000/CV2000/	CVM1/CV Series CV500/CV1000/CV2000/ CVM1 OPERATION MANUAL Ladder Diagrams
W195	CVM1 CV500/CV1000/CV2000/	CV-series CV500/CV1000/CV2000/CVM1 Programmable Controllers INSTALLATION GUIDE
W350	CVM1D	CVM1D Duplex System Programmable Controllers INSTALLATION GUIDE
W351	CVM1D	CVM1D Duplex System Programmable Controllers OPERATION MANUAL
W227	CV500/CV1000/ C200H/C1000H/C2000H/3G8F5	FINS Commands Reference Manual
W203	CV Series	CV Series Getting Started Guidebook

Special I/O Units

Man.No.	Model	Manual
W396	CJ1W-TC□□□	CJ Series Temperature Control Units OPERATION MANUAL
W401	CJ1W-CT021	CJ Series High-speed Counter Units OPERATION MANUAL
W397	CJ1W-NC□□3	CJ Series Position Control Units OPERATION MANUAL
W477	CJ1W-NC□□4	CJ Series Position Control Units OPERATION MANUAL
W345	CS1W-AD0□□-V1/-AD161 CS1W-DA0□□ CS1W-MAD44 CJ1W-AD0□□-V1/-AD042 CJ1W-DA0□□/-DA042V CJ1W-MAD42	CS/CJ Series Analog I/O Units OPERATION MANUAL
W368	CS1W-PTS□□ CS1W-PTW□□ CS1W-PDC□□ CS1W-PTR□□ CS1W-PPS□□ CS1W-PMV□□ CJ1W-PTS□□ CJ1W-PDC□□ CJ1W-PH41U	CS/CJ Series Analog I/O Units OPERATION MANUAL
W426	CS1W-NC□71 CJ1W-NC□71(-MA)	CS/CJ Series Position Control Units OPERATION MANUAL
W435	CS1W-MCH71 CJ1W-MCH71	CS/CJ series Motion Control Units OPERATION MANUAL
W336	CS1W-SCB□□-V1 CS1W-SCU□□-V1 CJ1W-SCU□□-V1	CS/CJ Series Serial Communications Boards Serial Communications Units OPERATION MANUAL
W440	CS1W-FLN22 CJ1W-FLN22(100BASE-TX)	CS/CJ Series FL-net Units OPERATION MANUAL
V236	CS1W-SPU01 CS1W-SPU02-V2 CJ1W-SPU01-V2	CS/CJ Series SPU Units OPERATION MANUAL
V237	WS02-SPTC1-V2	SPU-Console OPERATION MANUAL
W206	CV500-BSC11/21/31/41/51/61	CVM1/CV Series BASIC Units OPERATION MANUAL
W207	CV500-BSC11/21/31/41/51/61	CVM1/CV Series BASIC Units REFERENCE MANUAL
W254	CV500-MC221/421	CVM1/CV Series Motion Control Unit OPERATION MANUAL:INTRODUCTION
W255	CV500-MC221/421	CVM1/CV Series Motion Control Unit OPERATION MANUAL:DETAILS

Network Communications Units

Man.No.	Model	Manual
W309	CS1W-CLK23 CS1W-CLK21-V1 CJ1W-CLK23 CJ1W-CLK21-V1 C200HW-CLK21 CVM1-CLK21 CQM1H-CLK21 CS1W-RPT0□	Controller Link Units OPERATION MANUAL
W370	CS1W-CLK13 CS1W-CLK12-V1 CVM1-CLK12(H-PCF Cable) CS1W-CLK53 CS1W-CLK52-V1 CVM1-CLK52(GI Cable)	Optical Ring Controller Link Units OPERATION MANUAL
W465	CS1W-EIP21 CJ1W-EIP21 CJ2H-CPU6□-EIP CJ2M-CPU3□	CS/CJ Series EtherNet/IP Units OPERATION MANUAL
W420	CS1W-ETN21 CJ1W-ETN21 (100Base-TX)	CS/CJ Series Ethernet Units OPERATION MANUAL Construction of Networks
W421	CS1W-ETN21 CJ1W-ETN21(100Base-TX)	CS/CJ Series Ethernet Units OPERATION MANUAL Construction of Applications
W456	CS1W-CRM21 CJ1W-CRM21	CS/CJ Series CompoNet Master Units OPERATION MANUAL
W457	CRT1	CRT1 Series CompoNet Slave Units and Repeater Unit OPERATION MANUAL
W380	CS1W-DRM21-V1 CJ1W-DRM21	CS/CJ Series DeviceNet Units OPERATION MANUAL
W267	CS1W/CJ1W/C200HW DRT1/DRT2 GT1 CVM1	DeviceNet OPERATION MANUAL
W266	C200HW-SRM21-V1 CS1W-SRM21 CJ1W-SRM21 CQM1-SRM21-V1 SRT1/SRT2	CompoBus/S OPERATION MANUAL
W379	CVM1-DRM21-V1 C200HW-DRM21-V1	DeviceNet Master Units OPERATION MANUAL
W205	CV500-LK201	CVM1/CV Series OPERATION MANUAL: Host Link System, CV500-LK201 Host Link Unit
W213	CV500-SNT31	CV-series SYSMAC NET Link SYSTEM MANUAL
W242	CV500-ETN01	CV-Series Ethernet System Manual
W244	CV500-TDL21	CV-Series Temperature Controller Data Link Unit OPERATION MANUAL
W212	CV500-SLK11/21	CV-series SYSMAC LINK System Manual
W204	CV500-RM211/221 CV500-RT211/221	SYSMAC BUS/2 CV-series Remote I/O SYSTEM MANUAL
W348	DRT1-COM GT1	DeviceNet MULTIPLE I/O TERMINAL OPERATION MANUAL
W434	CVM1-LK401	CV/CVM1 Series PC Link Unit OPERATION MANUAL

Support Software

Man.No.	Model	Manual
W463	CXONE-AL□□C-V4	CX-One FA Integrated Tool Package SETUP MANUAL
W446	CXONE-AL□□D-V4	CX-Programmer OPERATION MANUAL
W447		CX-Programmer OPERATION MANUAL : Function Blocks/Structured Text
W469		CX-Programmer OPERATION MANUAL SFC Programming
W366		CX-Simulator OPERATION MANUAL
W464		CX-Integrator OPERATION MANUAL
W344		CX-Protocol OPERATION MANUAL
W433		CX-Position OPERATION MANUAL
W436		CX-Motion-NCF OPERATION MANUAL
W448		CX-Motion-MCH OPERATION MANUAL
W222	CVM1-PRS21-EV1	CVM1/CV-series Programming Console OPERATION MANUAL

Read and Understand this Document

Please read and understand this document before using the product. Please consult your OMRON representative if you have any questions or comments.

Warranty and Limitations of Liability

WARRANTY

OMRON's exclusive warranty is that the products are free from defects in materials and workmanship for a period of one year (or other period if specified) from date of sale by OMRON.

OMRON MAKES NO WARRANTY OR REPRESENTATION, EXPRESS OR IMPLIED, REGARDING NON-INFRINGEMENT, MERCHANTABILITY, OR FITNESS FOR PARTICULAR PURPOSE OF THE PRODUCTS. ANY BUYER OR USER ACKNOWLEDGES THAT THE BUYER OR USER ALONE HAS DETERMINED THAT THE PRODUCTS WILL SUITABLY MEET THE REQUIREMENTS OF THEIR INTENDED USE. OMRON DISCLAIMS ALL OTHER WARRANTIES, EXPRESS OR IMPLIED.

LIMITATIONS OF LIABILITY

OMRON SHALL NOT BE RESPONSIBLE FOR SPECIAL, INDIRECT, OR CONSEQUENTIAL DAMAGES, LOSS OF PROFITS OR COMMERCIAL LOSS IN ANY WAY CONNECTED WITH THE PRODUCTS, WHETHER SUCH CLAIM IS BASED ON CONTRACT, WARRANTY, NEGLIGENCE, OR STRICT LIABILITY.

In no event shall the responsibility of OMRON for any act exceed the individual price of the product on which liability is asserted.

IN NO EVENT SHALL OMRON BE RESPONSIBLE FOR WARRANTY, REPAIR, OR OTHER CLAIMS REGARDING THE PRODUCTS UNLESS OMRON'S ANALYSIS CONFIRMS THAT THE PRODUCTS WERE PROPERLY HANDLED, STORED, INSTALLED, AND MAINTAINED AND NOT SUBJECT TO CONTAMINATION, ABUSE, MISUSE, OR INAPPROPRIATE MODIFICATION OR REPAIR.

Disclaimers

CHANGE IN SPECIFICATIONS

Product specifications and accessories may be changed at any time based on improvements and other reasons.

It is our practice to change model numbers when published ratings or features are changed, or when significant construction changes are made. However, some specifications of the products may be changed without any notice. When in doubt, special model numbers may be assigned to fix or establish key specifications for your application on your request. Please consult with your OMRON representative at any time to confirm actual specifications of purchased products.

DIMENSIONS AND WEIGHTS

Dimensions and weights are nominal and are not to be used for manufacturing purposes, even when tolerances are shown.

PERFORMANCE DATA

Performance data given in this manual is provided as a guide for the user in determining suitability and does not constitute a warranty. It may represent the result of OMRON's test conditions, and the users must correlate it to actual application requirements. Actual performance is subject to the OMRON Warranty and Limitations of Liability.

ERRORS AND OMISSIONS

The information in this manual has been carefully checked and is believed to be accurate; however, no responsibility is assumed for clerical, typographical, or proofreading errors, or omissions.

Application Considerations

SUITABILITY FOR USE

OMRON shall not be responsible for conformity with any standards, codes, or regulations that apply to the combination of products in the customer's application or use of the products.

At the customer's request, OMRON will provide applicable third party certification documents identifying ratings and limitations of use that apply to the products. This information by itself is not sufficient for a complete determination of the suitability of the products in combination with the end product, machine, system, or other application or use.

The following are some examples of applications for which particular attention must be given. This is not intended to be an exhaustive list of all possible uses of the products, nor is it intended to imply that the uses listed may be suitable for the products:

- Outdoor use, uses involving potential chemical contamination or electrical interference, or conditions or uses not described in this manual.
- Nuclear energy control systems, combustion systems, railroad systems, aviation systems, medical equipment, amusement machines, vehicles, safety equipment, and installations subject to separate industry or government regulations.
- Systems, machines, and equipment that could present a risk to life or property.

Please know and observe all prohibitions of use applicable to the products.

NEVER USE THE PRODUCTS FOR AN APPLICATION INVOLVING SERIOUS RISK TO LIFE OR PROPERTY WITHOUT ENSURING THAT THE SYSTEM AS A WHOLE HAS BEEN DESIGNED TO ADDRESS THE RISKS, AND THAT THE OMRON PRODUCTS ARE PROPERLY RATED AND INSTALLED FOR THE INTENDED USE WITHIN THE OVERALL EQUIPMENT OR SYSTEM.

PROGRAMMABLE PRODUCTS

OMRON shall not be responsible for the user's programming of a programmable product, or any consequence thereof.

CV/CVM1 Replacement Guide

From CV/CVM1 to CJ2

Table of Contents

1. Work flow.....	2
2. Selecting the model.....	3
3. Reading data from CV/CVM1	6
4. Converting the program for CJ.....	8
5. Writing data to CJ.....	10
6. Appendix	12
Appendix A: Instruction conversion by the Change Model function of CX-Programmer	12
Appendix B: Difference in data area allocation.....	14
Appendix C: Difference in the PLC setting methods.....	15
Appendix D: Corresponding Input / Output Units.....	18

1. Work flow

This section describes the flow of work you have to follow when you replace CV/CVM1 CPU Units with CJ-series CPU Units. Read the reference pages for details.

1) Preliminary Steps: Take the following steps before starting the replacement work.

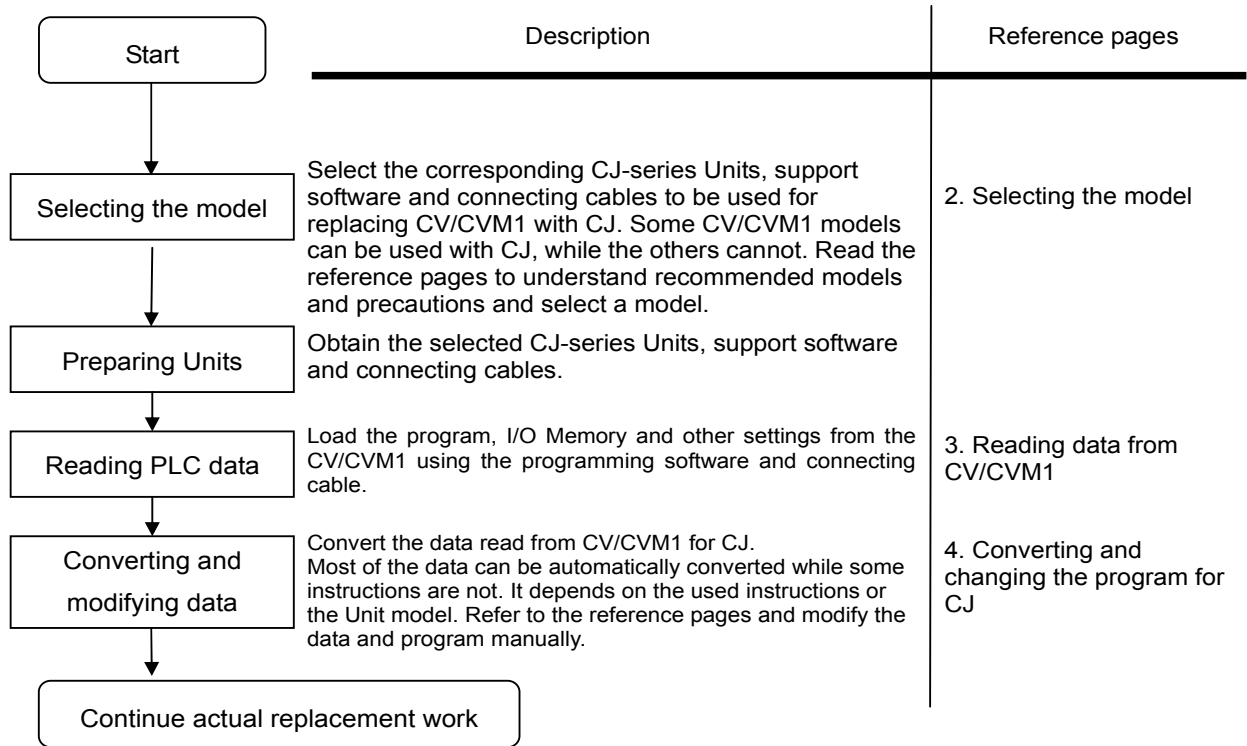

2) Actual replacement work flow: The following flow shows the procedure taken to replace the CV/CVM1 to CJ.

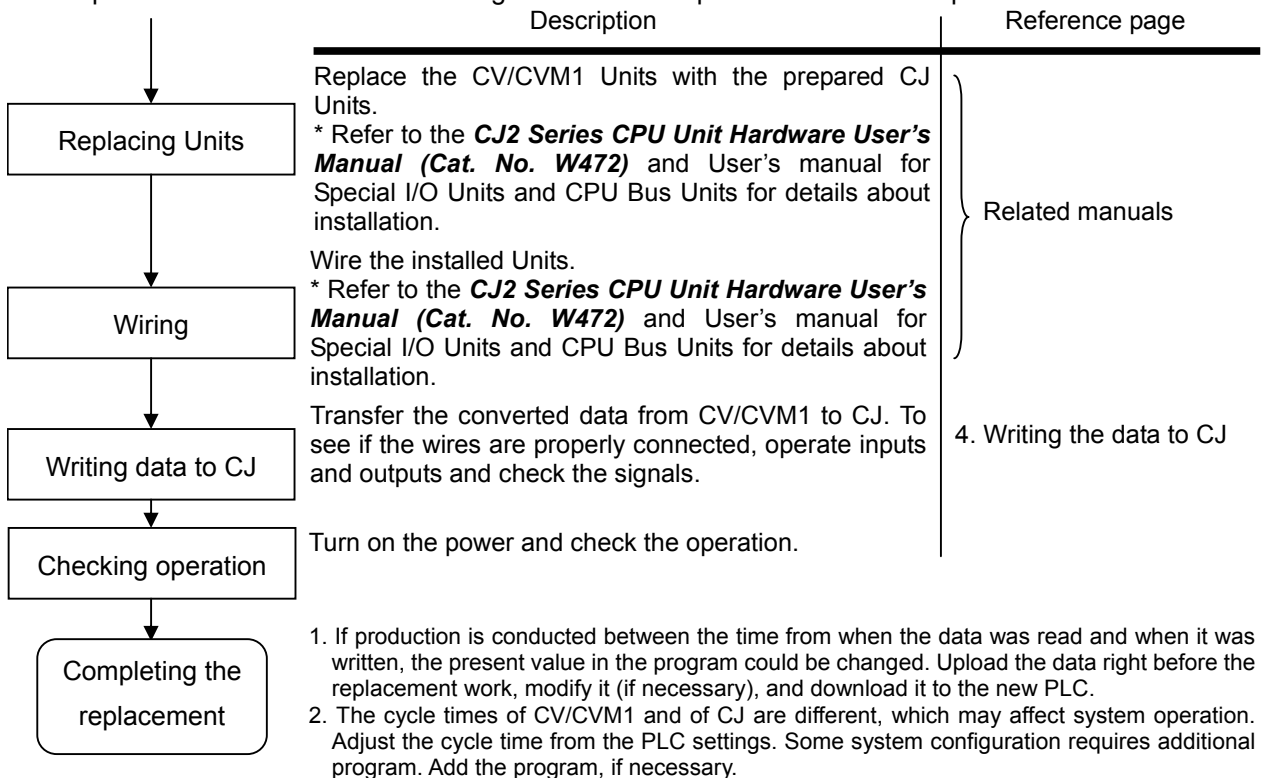

2. Selecting the model

Outline of the system configuration

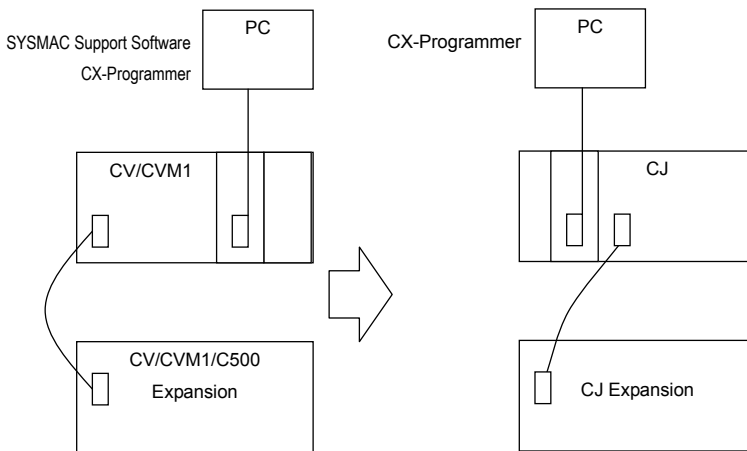

The table below lists the models of CV/CVM1 series Units and corresponding models of CJ-series Units. Select a CJ series model which is compatible with or one with similar specification to the CV/CVM1 series model you use.

Refer to the following manual for details of each model.

CJ2 Series CPU Unit Hardware User's Manual (Cat. No. W472)

CPU Rack

Unit name	CV/CVM1 series	CJ-series	Description
CPU Units	CV500-CPU01(-V1) CVM1-CPU01(-V1/V2) CVM1-CPU11(-V1/V2) ----- CV1000-CPU01(-V1) CV2000-CPU01(-V1) CVM1-CPU21(-V1/V2)	CJ2M-CPU14 to 15 CJ2M-CPU34 to 35 CJ2H-CPU64 CJ2H-CPU64-EIP ----- CJ2M-CPU15 CJ2M-CPU35 CJ2H-CPU64 to 65 CJ2H-CPU64 to 65-EIP	UM: CJ2M: 30K to 60K steps, CJ2H: 50K steps DM+EM: 160K words Number of expansions: 3 max. ----- UM: CJ2M: 60K steps CJ2H: 50K to 100K steps. DM+EM: 160K words Number of expansions: 3 max.
Memory card	HMC-ES□□□ (SRAM) HMC-EE□□□ (EEP-ROM) HMC-EP□□□ (EP-ROM)	HMC-EF□□□	Flash memory type only for CJ
Expansion Data Memory	CV1000-DM641 (64 KW) CV1000-DM151 (128 KW) CV1000-DM251 (256 KW)	Unnecessary	CJ-series CPU Units have built-in EM Area. The memory capacity is different by models. Select CPU Units with enough memory capacity.
Power Supply Units	CV500-PS221 CVM1-PA208 ----- CV500-PS211	CJ1W-PA205R CJ1W-PA205C CJ1W-PA202 ----- CJ1W-PD025 CJ1W-PD022	AC type Note: The Power Supply Units with a RUN Output have "R" at the end of their model No. ----- DC type Note: No RUN Output type provided.
CPU Backplanes	CV500-BC031 (3 slots) CV500-BC053 (5 slots) CV500-BC101 (10 slots) CVM1-BC053 (5 slots) CVM1-BC103 (10 slots)	Unnecessary	The CJ series does not use backplane in its configuration. However, attach an End Cover (CJ1W-TER01 that is attached to the CPU Unit to the right end of the CPU Rack).
Expansion Units (I/O Control Units)	CV500-IC101 CV500-IC201 CV500-IC301	CJ1W-IC101	The Unit is necessary when you use an expansion rack with CJ-series. The total extension length is 12 m or less. Note: No expansion exceeding 12 m is allowed.
Electrical Isolation Sleeve (CV500-ATT04/ATT05)	CV500-ATT04 CV500-ATT05	Unnecessary	The noise-preventing spacer is unnecessary for CJ, because CJ Units are installed by isolating from the control panel.

Expansion Rack

Unit name	CV/CVM1 series	CJ-series	Description
Power Supply Units	CV500-PS221 CVM1-PA208	CJ1W-PA205R CJ1W-PA205C CJ1W-PA202	AC type Note: RUN Output cannot be used on Expansion Racks.
	CV500-PS211	CJ1W-PD025 CJ1W-PD022	DC type Note: No RUN output type provided..
Backplanes (Expansion Backplanes)	<CPU Expansion Backplanes> CV500-B1111 (11 slots) <I/O Expansion Backplane> CV500-BI042 (4 slots) CV500-BI062 (6 slots) CV500-BI112 (11 slots) CVM1-BI064 (6 slots) CVM1-BI114 (4 slots) < I/O Backplanes for C500 > C500-BI□□□□	Unnecessary	The CJ series does not use backplane in its configuration. However, attach an End Cover (CJ1W-TER01 that is attached to the I/O Interface Unit) to the right end of the Expansion Rack.
Expansion Units (I/O Interface Units)	CV500-II101 CV500-II201 C500-II002	CJ1W-II101	The Unit is necessary when you use an expansion rack with CJ-series. The total extension length is 12 m or less. Note: No expansion exceeding 12 m is allowed.
Connecting Cables for Expansion Backplanes	< CPU Bus Cables > CV500-CN311 (30 cm) CV500-CN611 (60 cm)	< CJ/CS I/O Connecting Cables > CS1W-CN313 (30 cm) CS1W-CN713 (70 cm) CS1W-CN223 (2 m)	The cable connects a CJ-series CPU Rack or Extension Rack with another Expansion Rack. With CV/CVM1, you have to connect two cables between a CPU Unit and a CPU Expansion Rack: one is this connecting cable and the other is an I/O Cable. With CS/CJ, you need only one cable, i.e. an I/O Connection Cable for CS/CJ.
	< I/O Cables > CV500-CN312 (30 cm) CV500-CN612 (60 cm) CV500-CN122 (1 m) CV500-CN222 (2 m) CV500-CN322 (3 m) CV500-CN522 (5 m) CV500-CN132 (10 m) CV500-CN232 (20 m) CV500-CN332 (30 m) CV500-CN432 (40 m) CV500-CN532 (50 m)	< CJ/CS I/O Connecting Cables > CS1W-CN313 (30 cm) CS1W-CN713 (70 cm) CS1W-CN223 (2 m) CS1W-CN323 (3 m) CS1W-CN523 (5 m) CS1W-CN133 (10 m) CS1W-CN133-B2 (12 m)	With the CJ series, an I/O Interface Unit is always necessary to use an Expansion Rack.
	< I/O Cables (for connecting single Expansion I/O Rack via Backplanes) > CV500-CN413 (40 cm) CV500-CN613 (60 cm)	< CJ/CS I/O Connecting Cables > CS1W-CN313 (30 cm) CS1W-CN713 (70 cm) CS1W-CN223 (2 m)	With the CJ series, an I/O Interface Unit is always necessary to use an Expansion Rack.
	< I/O Cables for C500 > C500-CN312N (30 cm) C500-CN512N (50 cm) C500-CN812N (80 cm) C500-CN122N (1 m) C500-CN222N (2 m)	< CJ/CS I/O Connecting Cables > CS1W-CN313 (30 cm) CS1W-CN713 (70 cm) CS1W-CN223 (2 m)	With the CJ series, an I/O Interface Unit is always necessary to use an Expansion Rack.
Electrical Isolation Sleeve (CV500-ATT04/ATT05)	CV500-ATT04 CV500-ATT05	Unnecessary	The noise-preventing spacer is unnecessary for CJ, because CJ Units are installed by isolating from the control panel.

I/O Units & Special I/O Units

Unit name	CV/CVM1 series	CJ-series	Description
Basic I/O Units	C500-ID/IA/IM□□□□ C500-OD/OC/OA□□□□ C500-MD□□□□	CJ1W-ID/IA/IM□□□□ CJ1W-OD/OC/OA□□□□ CJ1W-MD□□□□	Use CJ-series Basic I/O Units. The terminal block wirings and input/output specifications are different.
	C500-□□□□□□	CJ1W-□□□□□□	Use CJ-series Special I/O Units. Replacement in this method involves change of the terminal block wirings and internal specifications.

Communications Unit

Unit name	CV/CVM1 series	CJ-series	Description
Special Units for communication	[SYSMAC LINK] Coaxial: CV500-SLK21 Optical Fiber Cable: CV500-SLK11	[SYSMAC LINK] None [Controller Link] Wire: CJ1W-CLK23 Optical Fiber Cable: None	SYSMAC LINK cannot be used with CJ-series CPU Units. We recommend you to use the Controller Link instead. Refer to <i>Controller Link Units OPERATION MANUAL (Cat. No. W309)</i> for details.
	[SYSNET] CV500-SNT31	[SYSNET] None [Controller Link] Wire: CJ1W-CLK23 Optical Fiber Cable: None	SYSNET cannot be used with CJ-series CPU Units. We recommend you to use the Controller Link instead. Refer to <i>Controller Link Units OPERATION MANUAL (Cat. No. W309)</i> for details.
	[Controller Link] Wire: CVM1-CLK21 Optical Fiber Cable: CVM1-CLK12/52	[Controller Link] Wire: CJ1W-CLK23 Optical Fiber Cable: None	You have to modify related areas such as status. Refer to <i>Controller Link Units OPERATION MANUAL (Cat. No. W309)</i> for details.
	[Host Link] CV500-LK201 RS232C×1, RS232C/RS422 switchable ×1	[Serial Communication Unit] CJ1W-SCU21-V1(RS232×2) CJ1W-SCU31-V1 (RS422/485 × 2), CJ1W-SCU41-V1 (RS232×1, RS422/485 × 1)	You have to change connecting cables and connectors, or modify related areas such as status area. Refer to <i>SYSMAC CS/CJ Series Serial Communications Board Serial Communications Unit OPERATION MANUAL (Cat No. W336)</i> for details.
	[PC Link] CVM1-LK401	[PC Link] None [Controller Link] Wire: CJ1W-CLK23 Optical Fiber Cable: None	PC Link cannot be used with CJ-series CPU Units. We recommend you to use the Controller Link instead. Refer to <i>Controller Link Units OPERATION MANUAL (Cat. No. W309)</i> for details.
	[DeviceNet] CVM1-DRM21(-V1)	[DeviceNet] CJ1W-DRM21	You have to modify I/O allocation areas. Refer to <i>DeviceNet Unit OPERATION MANUAL (Cat. No. W380)</i> for details.
	[SYSMAC BUS] Wire: C500-RM201. Optical Fiber Cable: C500-RM001-(P)(V1)	[SYSMAC BUS] None [CompoNet] CJ1W-CRM21 or [DeviceNet] CJ1W-DRM21 or [CompoBus/S] CJ1W-SRM21	SUSMAC BUS cannot be used with CJ-series CPU Units. We recommend you to replace with other remote Unit (CompoNet, DeviceNet or CompoBus/S) instead. Refer to <i>CompoNet Master Units OPERATION MANUAL (Cat. No. W456)</i> and <i>CRT1 Series CompoNet Slave Units and Repeater Units OPERATION MANUAL (Cat. Not. W457)</i> for details of CompoNet. Refer to <i>CS/CJ Series DeviceNet Units OPERATION MANUAL (Cat. No. W380)</i> for details of DeviceNet. Refer to <i>CompoBus/S OPERATION MANUAL (Cat. No. W266)</i> for details of CompoBus/S.
[SYSMAC BUS/2] Wire: CV500-RM221 master CV500-RT221 slave Optical Fiber Cable: CV500-RM211 master CV500-RT211 slave	[SYSMAC BUS/2] None [CompoNet] CJ1W-CRM21 or [DeviceNet] CJ1W-DRM21 or [CompoBus/S] CJ1W-SRM21	SUSMAC BUS/2 cannot be used with CJ-series CPU Units. We recommend you to replace with other remote Unit (CompoNet, DeviceNet or CompoBus/S) instead. Refer to <i>CompoNet Master Units OPERATION MANUAL (Cat. No. W456)</i> and <i>CRT1 Series CompoNet Slave Units and Repeater Units OPERATION MANUAL (Cat. Not. W457)</i> for details of CompoNet. Refer to <i>CS/CJ Series DeviceNet Units OPERATION MANUAL (Cat. No. W380)</i> for details of DeviceNet. Refer to <i>CompoBus/S OPERATION MANUAL (Cat. No. W266)</i> for details of CompoBus/S.	

Support software and Programming devices

Product Name	CV/CVM1 series	CJ-series	Description
Support software	CV Support Software SYSMAC Support Software CX-Programmer	[CJ2H] CX-Programmer Ver.8.0 or higher [CJ2M] CX-Programmer Ver.9.1 or higher	Only CX-Programmer can be used with CJ-series CPU Units. CX-Programmer is included in Omron CX-One FA integrated Tool Package.
Factory intelligent terminal	FIT10 FIT20	None	Use commercially available personal computers.
PLC-PC connecting cable	CV500-CIF01	USB cable on the market (A connector - B Connector)	Use a cable (no longer than 5 m) for USB2.0.
Programming Console (Connecting cable)	CV500-PRS21 (CV500-CN[[4])	None	Programming Console cannot be used with CJ2-series CPU Unit. Use CX-Programmer.

3. Reading data from CV/CVM1

Use the CX-Programmer, and read the ladder programs, PLC settings and Data Memory from the CV/CVM1.

Required items	Support software (PC)	CX-One (CXONE-AL[C-V], CXONE-AL[D-V]) Or, CX-Programmer (WS02-CXPC[V])
	Connecting cable	CV500-CIF01 + Conversion connector of D-SUB25 pin (female)-9 pins (female) + CS1W-CIF31

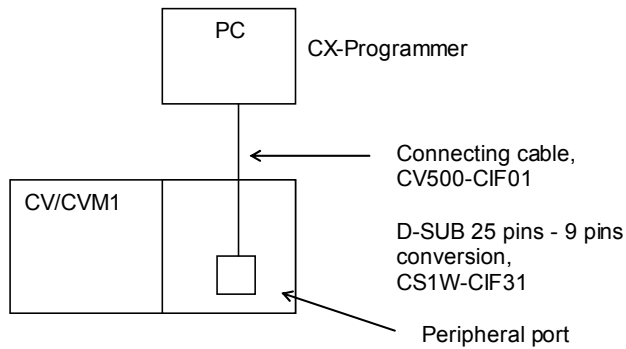

- (1) Mount the peripheral interface (CV500-CIF01) to the CV/CVM1 CPU unit, and connect it with the personal computer.
- (2) Start up the CX-Programmer. (From the Windows Start menu, select **All Programs - OMRON - CX-One - CX-Programmer - CX-Programmer.**)
- (3) Select CV500, CV1000, CV2000, CVM1 or CVM1-V2 for the Device Type. (Select **File – New** to show the below dialog box.) (The following example selects CVM1-CPU21-V2.)

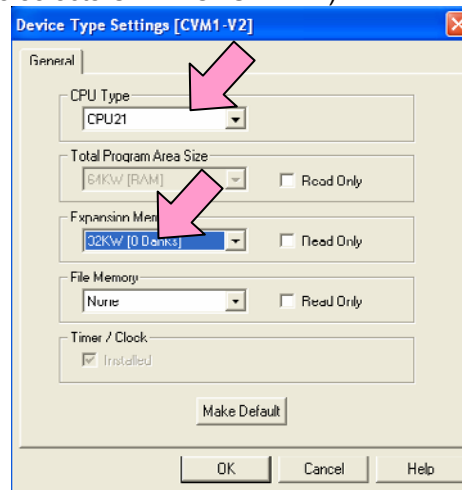
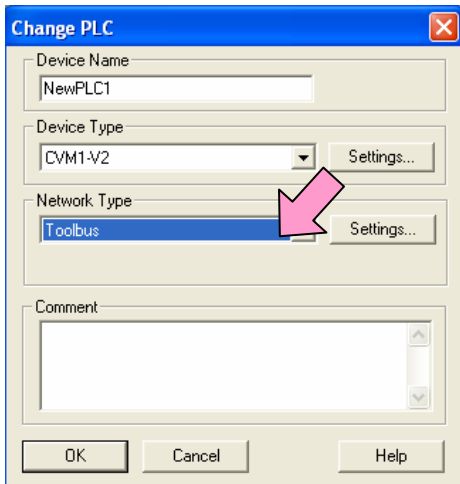

- (4) Connect the PLC and the CX-Programmer online. (Select **PLC - Work Online**)

- (5) Load ladder programs, PLC setting and I/O table from the CV/CVM1. (Select **PLC – Transfer – From PLC to PC.**) Click the **OK** Button to read them.

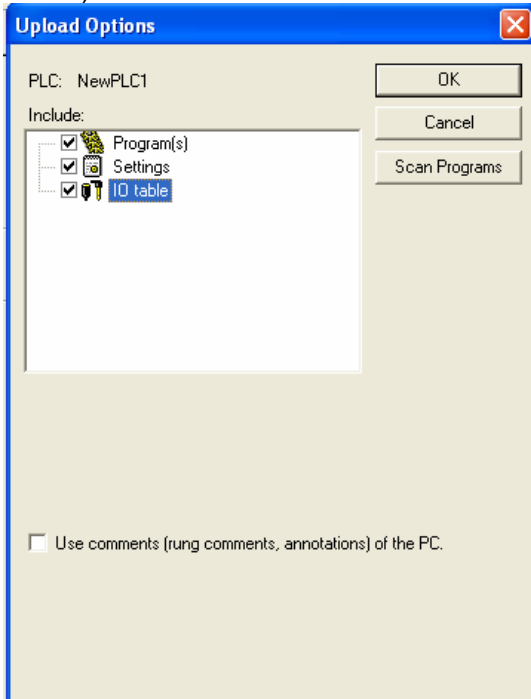

- (6) Load the PLC memory data (Data Memory). (Select **PLC – Edit - Memory.**)

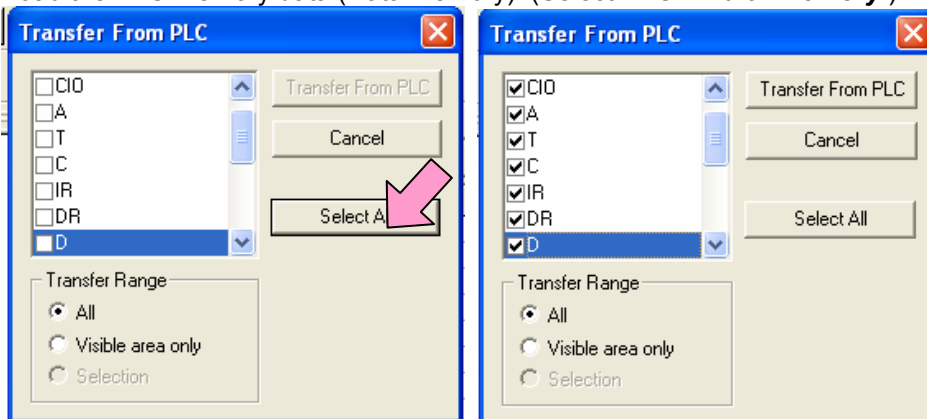

Scroll and check all the areas. Press the **Transfer From PLC** Button to start loading.

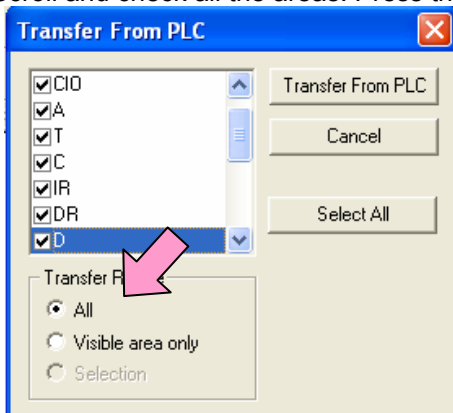

- (7) Make the CX-Programmer offline. (Select **PLC – Work online**)
 (8) Save the program by specifying the project name. (Select **File - Save As**)

4. Converting the program for CJ

On the CX-Programmer, convert the program for CJ.

- (1) Start the CX-Programmer, and open the program file for CV/CVM1. (Select **File - Open**)
- (2) Change the Device Type from CV/CVM1 to CJ2. (Select **PLC - Change Model** to show the below dialog box.)
 - * Keep the data loaded from CV/CVM1 when you change the model to convert the program. The only data that can be converted is ladder program. The others will be cleared to default state.

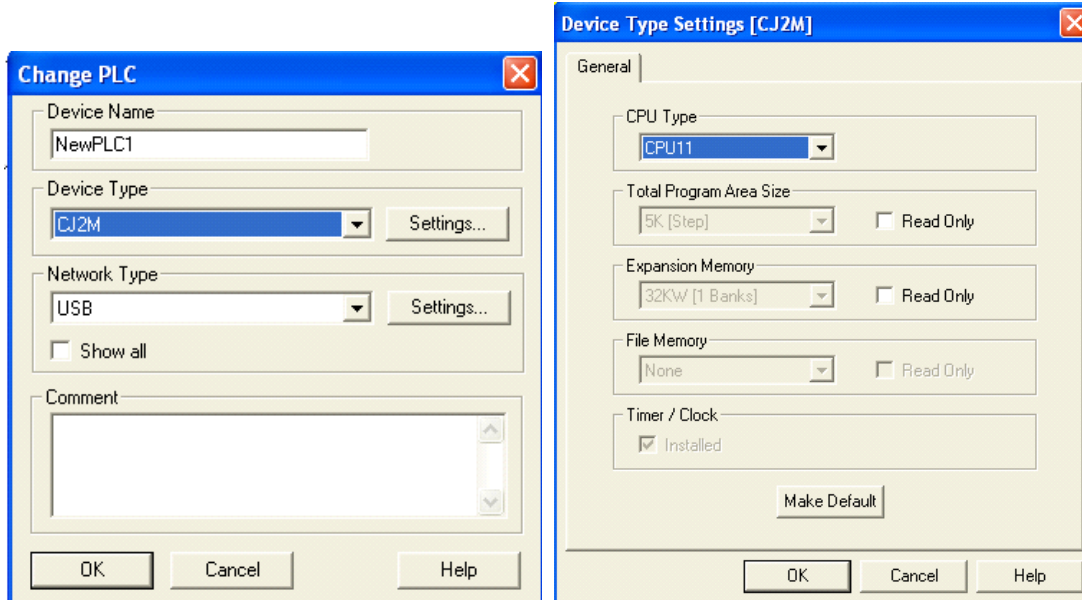

- (3) The instructions are converted. The Output Window shows the conversion results. Double-click an error shown on the Output Window to jump to the corresponding section of the ladder program.

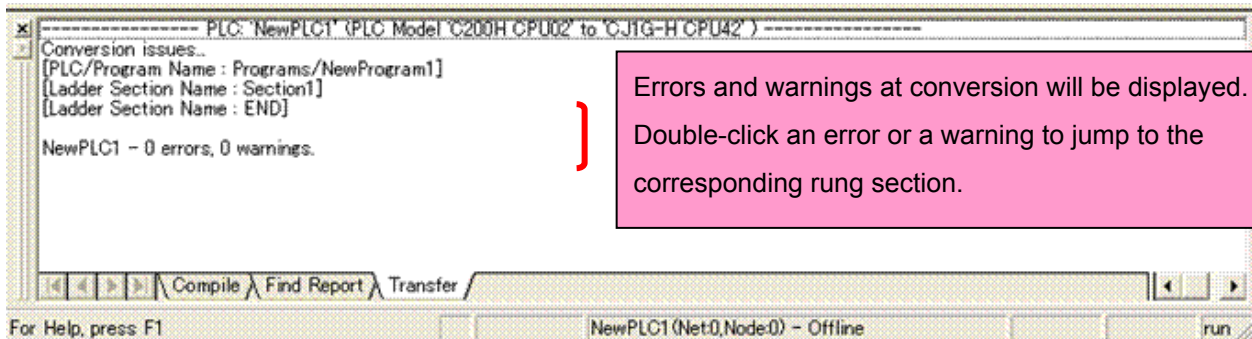

Some instructions can not be converted. In that case, modify the ladder program according to the procedures in *Appendix A. Instruction conversion by the Change Model function of CX-Programmer*. You can check the program by selecting **Program - Compile**. The Output Window shows the checking results. Be sure to execute the Program Check because there is an instruction to which an error is not displayed when the model is changed.

- (4) The PLC memory data cannot be maintained when the PLC model is changed. Open the PLC Memory windows for both CV/CVM1 and CJ-series PLCs, and copy the necessary memory data after conversion.

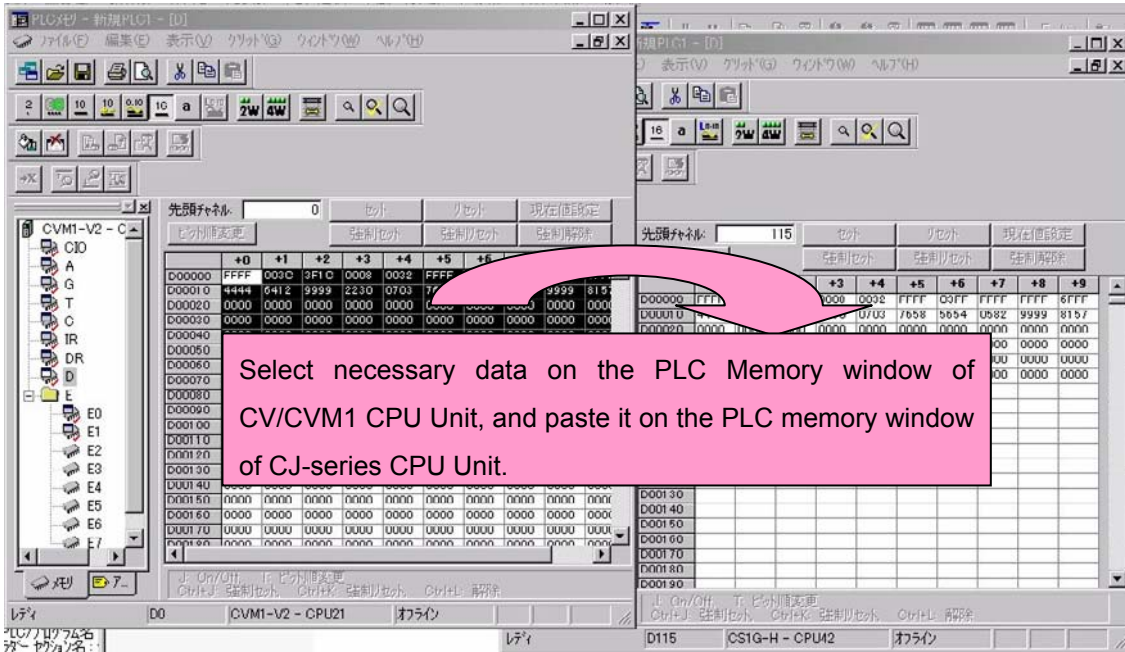

- (5) CV/CVM1 and CJ-series are different in the I/O allocation. Refer to *Appendix B. Difference in data area allocation*, and modify the ladder program.
- (6) CV/CVM1 and CJ-series are different in a part of PLC setting. Refer to *Appendix C. Change in PLC settings*, and change the PLC settings.
- (7) Check the program. If an error is detected, correct it. (Select **Program - Compile (Program Check)**)
- (8) Save the program by specifying the project name. (Select **File - Save As**)

5. Writing data to CJ

Transfer the converted and modified programs, PLC settings and data memory to CJ-series CPU Unit.

Required items	Support software (PC)	CX-One CXONE-AL[C-V]/ AL[D-V] (CX-Programmer)
	Connecting cable	Commercially available USB cable

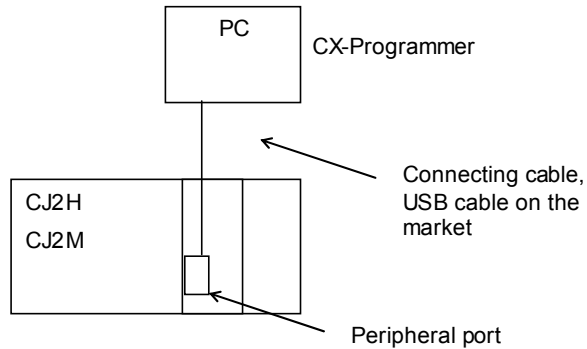

- (1) Connect the CJ and the PC.
- (2) Start up the CX-Programmer, and open the program file for CJ that you converted or changed.
- (3) Connect the CJ and CX-Programmer online.
- (4) Transfer the ladder program. (Select **PLC - Transfer – To PLC.**) Select the checkbox for **Program**. Press the **OK** Button to start transfer.

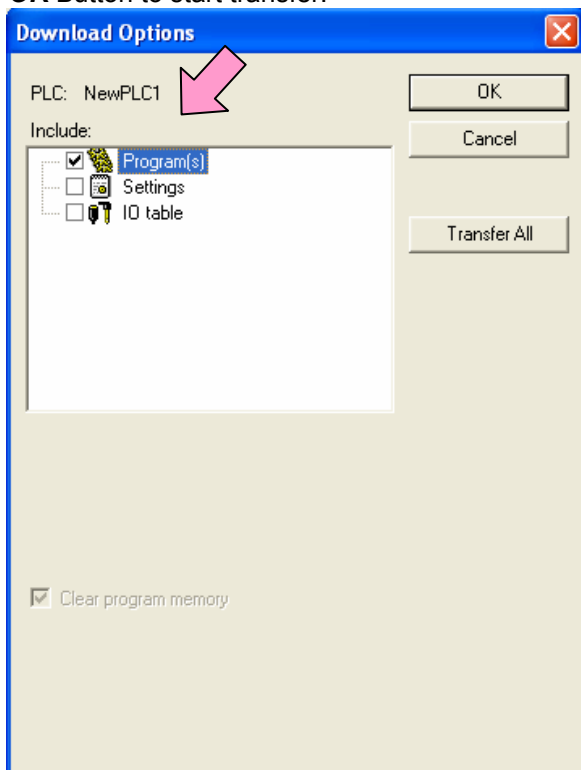

(5) Transfer the PLC memory (Select D (Data Memory)). (Select **PLC – Edit – Memory.**)

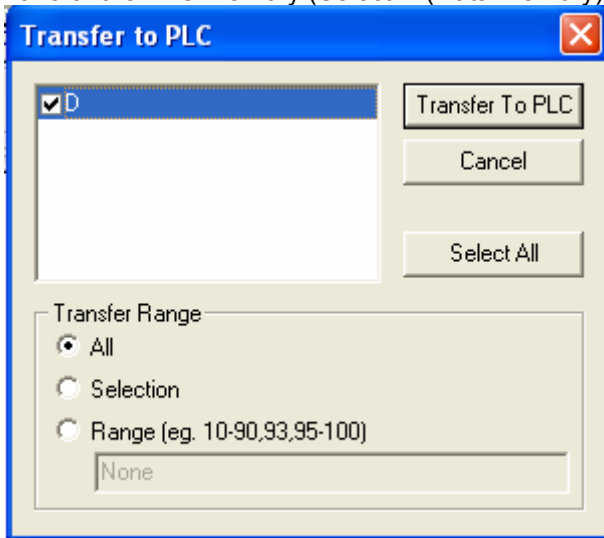

(6) Make the CX-Programmer offline.

6. Appendix

Appendix A: Instruction conversion by the Change Model function of CX-Programmer

- (1) The data type of operand is changed from BCD to BIN data for some instructions.
- (2) The number of operands is changed for some instructions.
- (3) Interrupt control instructions must be changed. (Use MSKS, MSKR, CLI, DI, and EI.)

Refer to the table below for detail. The table contains only the instructions whose states will differ by conversions. The other instructions are converted in the same state. Due to difference in CPU Unit versions or CX-Programmer versions, however, a part of these instructions can not be converted or cause different operations. Be sure to read the following related manuals and to perform operation tests to confirm that there is no problem.

SYSMAC CS/CJ/NSJ Series INSTRUCTIONS REFERENCE MANUAL (Cat. No. W474)
CJ2 CPU Unit Software USER'S MANUAL (Cat. No. W473)
CS/CJ/NJS PROGRAMMING MANUAL (Cat. No. W394)
CX-Programmer Ver9.[] OPERATION MANUAL SFC Programming (Cat. No. W469)

CV/CVM1 instruction	CJ-series Instruction	Operand	Number of Operands
JMP(4)	JMP(4) or JMP0(515)	If the operand data is #0, this instruction is automatically converted to JMP0, and the operand data is deleted. In other cases, the operation remains the same.	Changes from 1 to 0, or remains the same.
JME(5)	JME(5) or JME0(516)	If the operand data is #0, this instruction is automatically converted to JME0, and the operand data is deleted. In other cases, the operation remains the same.	Changes from 1 to 0, or remains the same.
STEP(8)	STEP(8)	The operand data must be set by Work Area (WR) or Index Resistors (indirect). Change the operand.	Same as CV/CVM1
SNXT(9)	SNXT(9)	The operand data must be set by Work Area (WR) or Index Resistors (indirect). Change the operand.	Same as CV/CVM1
EQU(25)	=(300)	Same as CV/CVM1	Same as CV/CVM1
MOVQ(37)	MOV(21)	Same as CV/CVM1	Same as CV/CVM1
XFER(40)	XFERC(565)	Same as CV/CVM1	Same as CV/CVM1
MOVB(42)	MOVBC(568)	Same as CV/CVM1	Same as CV/CVM1
DIST(44)	DISTC(566)	Same as CV/CVM1	Same as CV/CVM1
COLL(45)	COLLC(567)	Same as CV/CVM1	Same as CV/CVM1
BXFR(46)	None	This instruction is not supported. Consider programming with the XFER instruction.	
SETA(47)	SETA(530)	The data types of the 2nd and 3rd operands are changed from BCD to BIN. For a constant, the # mark is converted to & mark. To use word data, change the data type of word from BCD to BIN.	Same as CV/CVM1
RSTA(48)	RSTA(531)	The data types of the 2nd and 3rd operands are changed from BCD to BIN. For a constant, the # mark is converted to & mark. To use word data, change the data type of word from BCD to BIN.	Same as CV/CVM1
NSFL(54)	NSFL(578)	The data types of the 2nd and 3rd operands are changed from BCD to BIN. For a constant, the # mark is converted to & mark. To use word data, change the data type of word from BCD to BIN.	Same as CV/CVM1
NSFR(55)	NSFR(579)	The data types of the 2nd and 3rd operands are changed from BCD to BIN. For a constant, the # mark is converted to & mark. To use word data, change the data type of word from BCD to BIN.	Same as CV/CVM1
NASL(56)	NASL(580)	The data type of the 2nd operand is changed from BCD to BIN. For a constant, the # mark is converted to & mark. To use word data, change the data type of word from BCD to BIN.	Same as CV/CVM1
NASR(57)	NASR(581)	The data type of the 2nd operand is changed from BCD to BIN. For a constant, the # mark is converted to & mark. To use word data, change the data type of word from BCD to BIN.	Same as CV/CVM1
NSLL(58)	NSLL(582)	The data type of the 2nd operand is changed from BCD to BIN. For a constant, the # mark is converted to & mark. To use word data, change the data type of word from BCD to BIN.	Same as CV/CVM1
NSRL(59)	NSRL(583)	The data type of the 2nd operand is changed from BCD to BIN. For a constant, the # mark is converted to & mark. To use word data, change the data type of word from BCD to BIN.	Same as CV/CVM1
ADD(70)	+BC(406)	Same as CV/CVM1	Same as CV/CVM1
SUB(71)	-BC(416)	Same as CV/CVM1	Same as CV/CVM1
MUL(72)	*B(424)	Same as CV/CVM1	Same as CV/CVM1
DIV(73)	/B(434)	Same as CV/CVM1	Same as CV/CVM1
ADDL(74)	+BCL(407)	Same as CV/CVM1	Same as CV/CVM1
SUBL(75)	-BCL(417)	Same as CV/CVM1	Same as CV/CVM1
MULL(76)	*BL(425)	Same as CV/CVM1	Same as CV/CVM1
DIVL(77)	/BL(435)	Same as CV/CVM1	Same as CV/CVM1
ADB(80)	+C(402)	Same as CV/CVM1	Same as CV/CVM1
SBB(81)	-C(412)	Same as CV/CVM1	Same as CV/CVM1
MLB(82)	*U(422)	Same as CV/CVM1	Same as CV/CVM1
DVB(83)	/U(432)	Same as CV/CVM1	Same as CV/CVM1
ADBL(84)	+CL(403)	Same as CV/CVM1	Same as CV/CVM1
SBBL(85)	-CL(413)	Same as CV/CVM1	Same as CV/CVM1
MLSL(86)	*UL(423)	Same as CV/CVM1	Same as CV/CVM1
DVBL(87)	/UL(433)	Same as CV/CVM1	Same as CV/CVM1
INC(90)	++B(452)	Same as CV/CVM1	Same as CV/CVM1
DEC(91)	--B(454)	Same as CV/CVM1	Same as CV/CVM1
INCB(92)	++(448)	Same as CV/CVM1	Same as CV/CVM1
DECB(93)	--(450)	Same as CV/CVM1	Same as CV/CVM1
INCL(94)	++BL(453)	Same as CV/CVM1	Same as CV/CVM1
DECL(95)	--BL(455)	Same as CV/CVM1	Same as CV/CVM1
INBL(96)	++L(449)	Same as CV/CVM1	Same as CV/CVM1
DCBL(97)	--L(451)	Same as CV/CVM1	Same as CV/CVM1
BCNT(114)	BCNTC(621)	Same as CV/CVM1	Same as CV/CVM1

CV/CVM1 instruction	CJ-series Instruction	Operand	Number of Operands
LINE(115)	LINE(63)	The data type of the 2nd operand is changed from BCD to BIN. For a constant, the # mark is converted to & mark. To use word data, change the data type of word from BCD to BIN.	Same as CV/CVM1
COLM(116)	COLM(64)	The data type of the 2nd operand is changed from BCD to BIN. For a constant, the # mark is converted to & mark. To use word data, change the data type of word from BCD to BIN.	Same as CV/CVM1
TCNT(123)	None	This instruction is not supported. Consider programming with the CNT instruction.	
TSR(124)	TSR(780)	The data specification of the operand is different. Refer to the SYSMAC CS/CJ/NSJ Series INSTRUCTIONS REFERENCE MANUAL (Cat No. W474), and correct the data.	Same as CV/CVM1
TSW(125)	TSW(781)	The data specification of the operand is different. Refer to the SYSMAC CS/CJ/NSJ Series INSTRUCTIONS REFERENCE MANUAL (Cat No. W474), and correct the data.	Same as CV/CVM1
SSET(160)	SSET(630)	The data specification of the operand is different. Refer to the SYSMAC CS/CJ/NSJ Series INSTRUCTIONS REFERENCE MANUAL (Cat No. W474), and correct the data.	Same as CV/CVM1
SRCH(164)	SRCH(181)	The data specification of the operand is different. Refer to the SYSMAC CS/CJ/NSJ Series INSTRUCTIONS REFERENCE MANUAL (Cat No. W474), and correct the data.	Same as CV/CVM1
MAX(165)	MAX(182)	The data specification of the operand is different. Refer to the SYSMAC CS/CJ/NSJ Series INSTRUCTIONS REFERENCE MANUAL (Cat No. W474), and correct the data.	Same as CV/CVM1
MIN(166)	MIN(183)	The data specification of the operand is different. Refer to the SYSMAC CS/CJ/NSJ Series INSTRUCTIONS REFERENCE MANUAL (Cat No. W474), and correct the data.	Same as CV/CVM1
SUM(167)	SUM(184)	The data specification of the operand is different. Refer to the SYSMAC CS/CJ/NSJ Series INSTRUCTIONS REFERENCE MANUAL (Cat No. W474), and correct the data.	Same as CV/CVM1
EMBC(171)	EMBC(281)	The data type of operand is changed from BIN data to BCD. For a constant, the # mark is converted to & mark. To use word data, change the data type of word from BCD to BIN.	Same as CV/CVM1
REGL(175)	None	This instruction is not supported. Consider programming with another data transfer instruction.	
REGS(176)	None	This instruction is not supported. Consider programming with another data transfer instruction.	
FPD(177)	FPD(269)	The data specification of the operand is different. Refer to the SYSMAC CS/CJ/NSJ Series INSTRUCTIONS REFERENCE MANUAL (Cat No. W474), and correct the data.	Same as CV/CVM1
FILR(180)	None	This instruction is not supported. Consider programming with the FREAD instruction.	
FILW(181)	None	This instruction is not supported. Consider programming with the FWRIT instruction.	
FILP(182)	None	This instruction is not supported. Consider the online editing or so.	
FLSP(183)	None	This instruction is not supported. Consider the online editing or so.	
IOSP(187)	None	This instruction is not supported. Consider selecting "Normal" for the Execution Mode of CS/CJ. (Select "Normal" for the Execution mode on Peripheral Service tab on the PLC Settings window.)	
IORS(188)	None	This instruction is not supported. Consider selecting "Normal" for the Execution Mode of CS/CJ. (Select "Normal" for the Execution mode on Peripheral Service tab on the PLC Settings window.)	
IODP(189)	None	This instruction is not supported. Consider displaying on a touch panel or so.	
READ(190)	None	This instruction is not supported. Consider programming with the IORD instruction. The data of the Special I/O Unit is reflected directly in the I/O memory of PLC. Please refer to the operation manual of the Special I/O Unit that you use.	
WRIT(191)	None	This instruction is not supported. Consider programming with the IOWR instruction. The data that is written to the I/O memory of PLC is directly reflected to the Special I/O Unit. Please refer to the operation manual of the Special I/O Unit that you use.	
MSG(195)	MSG(46)	The data type of the 1st operand is changed from BCD to BIN. For a constant, the # mark is converted to & mark. To use word data, change the data type of word from BCD to BIN.	Same as CV/CVM1
TOUT	None	This instruction is not supported. Consider programming with the OUT instruction.	
SA(210)	SA(784)	The data specification of operand is different. Refer to the SYSMAC CS/CJ/NSJ Series INSTRUCTIONS REFERENCE MANUAL (Cat. No. W474) and CX-Programmer Ver.9.[] OPERATION MANUAL SFC Programming (Cat. No. W469), and correct the data.	Same as CV/CVM1
SP(211)	None	This instruction is not supported. Consider programming with another SFC related instruction.	
SR(212)	None	This instruction is not supported. Consider programming with another SFC related instruction.	
SF(213)	None	This instruction is not supported. Consider programming with another SFC related instruction.	
SE(214)	SE(785)	The data specification of operand is different. Refer to the SYSMAC CS/CJ/NSJ Series INSTRUCTIONS REFERENCE MANUAL (Cat. No. W474) and CX-Programmer Ver.9.[] OPERATION MANUAL SFC Programming (Cat. No. W469), and correct the data.	Same as CV/CVM1
SOFF(215)	None	This instruction is not supported. Consider programming with another SFC related instruction.	
CJP(221)	CJP(510)	The data type of operand is changed from BCD to BIN. For a constant, the # mark is converted to & mark. To use word data, change the data type of word from BCD to BIN.	Same as CV/CVM1
CJPN(222)	CJPN(511)	The data type of operand is changed from BCD to BIN. For a constant, the # mark is converted to & mark. To use word data, change the data type of word from BCD to BIN.	Same as CV/CVM1
CNR(236)	CNR(545)	The data specification of the operand is different. Refer to the SYSMAC CS/CJ/NSJ Series INSTRUCTIONS REFERENCE MANUAL (Cat No. W474), and correct the data.	It might be different.
PID(270)	PID(190)	The data specification of the operand is different. Refer to the SYSMAC CS/CJ/NSJ Series INSTRUCTIONS REFERENCE MANUAL (Cat No. W474), and correct the data.	Same as CV/CVM1
RD2(280)	None	This instruction is not supported. Consider programming with the IORD instruction. The data of the Special I/O Unit is reflected directly in the I/O memory of PLC. Please refer to the operation manual of the Special I/O Unit that you use.	
WR2(281)	None	This instruction is not supported. Consider programming with the IOWR instruction. The data that is written to the I/O memory of PLC is directly reflected to the Special I/O Unit. Please refer to the operation manual of the Special I/O Unit that you use.	
TST(350)	TST(350)	The data type of the 2nd operand is changed from BCD to BIN. For a constant, the # mark is converted to & mark. To use word data, change the data type of word from BCD to BIN.	Same as CV/CVM1
TSTN(351)	TSTN(351)	The data type of the 2nd operand is changed from BCD to BIN. For a constant, the # mark is converted to & mark. To use word data, change the data type of word from BCD to BIN.	Same as CV/CVM1

Appendix B: Difference in data area allocation

This table outlines the difference in the data allocation between CV/CVM1 and CJ. Refer to the related manuals for details.

Item	CV/CVM1-series	CJ-series	Remark
I/O allocation Basic I/O Units	"Free location and free words allocation" CIO 0 to 127 (The number of words differs by models.) CIO 0 to 511 (When you set the words allocated to each rack.)	"Free location and free words allocation" CIO 0 to 319 (The number of words differs by models.) CIO 0 to 999 (When you set the words allocated to each rack)	Refer to <i>CJ2 CPU Unit Software USER's MANUAL (Cat. No. W473)</i> for details of the I/O allocation.
I/O allocation Special I/O Units	"Free location and free words allocation" CIO 0 to 127 (The number of words differs by models.) 0 to 511 words (When you set the words allocated to each rack.)	CIO 2,000 to 2,199 (Allocates 10 words for each Unit No.) DM 20,000 to 21,999 (Allocates 100 words for each Unit No.)	
I/O allocation CPU Bus Units	CIO 1,500 to 1,899 (Allocates 25 words for each Unit No.) DM 2,000 to 3,599 (Allocates 100 words for each Unit No.)	1,500 to 1,899 words (Allocates 25 words for each Unit No.) DM30,000 to 31,599 (Allocates 100 words for each Unit No.)	
I/O allocation SYSMAC BUS	CIO 2,300 to 2,555 (default)	None. [Allocation of other remote I/O] DeviceNet: I/O allocation of CPU Bus Unit CompoNet: I/O allocation of Special I/O Unit CompoBus/S: I/O allocation of Special I/O Unit	CJ series CPU do not support SYSMAC BUS. Consider switching to other remote I/O system.
I/O allocation SYSMAC BUS/2	CIO 200 to 999 (default)	None [Allocation of other remote I/O] DeviceNet: I/O allocation of CPU Bus Unit CompoNet: I/O allocation of Special I/O Unit CompoBus/S: I/O allocation of Special I/O Unit	CJ series CPU do not support SYSMAC BUS/2. Consider switching to other remote I/O system.
I/O allocation DeviceNet	CIO 1,900 to 1,963 CIO 2,000 to 2,063	[DeviceNet for CJ] I/O allocation of CPU Bus Unit	
Work Area (WR)	CIO 0032(*) to 0199 (* The start word differs by models.) CIO 1,964 to 1,999 CIO 2,064 to 2,299	CIO 1,200 to 1,499 CIO 3,800 to 6,143 W000 to 511	Areas unused for can be used as Work Area with CJ. However, some area will be used for future expansion. Therefore, do not use the area.
Data Link Area	1000 to 1199 words D0000 to 0127 (By default)	1000 to 1199 words	
Holding Area (HR)	1200 to 1499 words	H000 to 511 words	
Temporary Relay Area (TR)	TR0 to 7	TR0 to 15	
CPU Bus Link Area	G000 to 255	G000 to 004: AR G008 to 255: None	CPU status and the clock have been allocated to Auxiliary Area (AR) with CJ series CPU Unit.
Auxiliary Area	A000 to 511	(1) AR Area and Bit: Change the word address and bit address used in the program. (2) Condition Flag and clock pulse: Change the operation flags in the program to the condition flags and the clock pulse respectively. Use global variables such as P_0_1ms, and P_1ms instead of clock pulse.	The operation flag and the Condition Flag are specified with the label.

Appendix C: Difference in the PLC setting methods

This section explains the difference of PLC settings on CV/CVM1 and CJ-series CPU Units.

The figure below shows the (1) setting tab on the PLC Settings window, (2) Group of settings in the tab, and (3) Setting items in each group. Check the circle and square check boxes for your settings. Be sure to confirm the system safety and system operation, though most of settings are same for both CV/CVM1 and CJ-series.

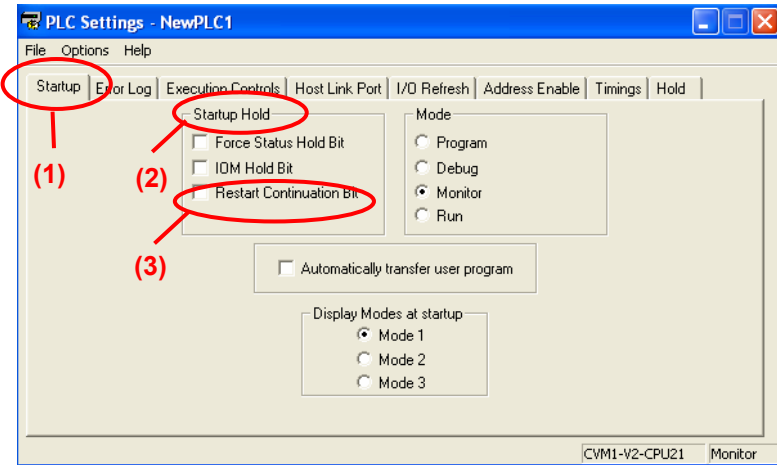

CV/CVM1 CPU Unit	CJ-series CPU Unit	Remark
Startup Startup Hold - Forced Status Hold Bit	Startup Startup Hold - Forced Status Hold Bit	Settings to hold the force on/off status and at power interruption. If this setting is enabled, status is maintained when the power is turned on again. There is no functional difference between the CV/CVM1 and CJ.
Startup hold Startup Startup Hold - IOM Hold Bit	Startup Startup Hold - IOM Hold Bit	Settings to hold the I/O memory hold bits status at power interruption. The status is maintained when the power is turned on. There is no functional difference between the CV.CVM1 and CJ.
Startup Startup Hold - Restart Continuation Bit	None	Setting to hold the status of restart continuation bits at power interruption. The status is maintained when the power is turned on. There are no restart continuation bits on the CJ.
Startup Mode - Program - Debug - Monitor - Run	Mode Operating mode - Program - Monitor - Run - Use programming console (Run)	Specifies the operating mode at power on. There is no debug mode on the CJ. To debug the program, use CX-Simulator. The programming console can not be used with CJ2; Operating mode can not be changed with a programming console.
Startup - Automatically transfer user programs	None	Specifies whether to transfer user program from the memory card at power on, or not. For CJ, it can not be set from the PLC Settings. It is set with the DIP switches on the front panel of CPU Unit.
Startup display Display Mode at startup - Mode 1 - Mode 2 - Mode 3	None	Specifies the display mode for the 7 segment indicators on the expansion unit or SYSMAC BUS/2 system. CJ series does not have this function. Consider using a touch panel to display this information, if necessary.
Error log - Enable Error Log.	None	Specifies the area to save error logs and number of logs to be saved. With CJ, error log area is fixed.
Execution Controls Execution Process - Synchronous - Asynchronous	Peripheral Service Sync/Async Comms Execution mode - Normal - Peripheral Service - Synchronous - Asynchronous	Specifies whether to synchronize the execution of PLC instructions and peripheral servicing. For CJ1, select "Normal" to synchronize them and select other one for asynchronous execution. For CJ2, only "Normal" can be selected. The various execution modes as shown on the left may have different operations. Be sure to check the effect of this setting onto operation.

Execution Controls Indirect DM - Binary - BCD	None	Selects data type (Binary or BCD) to be used for Indirect DM. CJ specifies the indirect DM by using the settings below in the program. BIN mode: D with @ BCD mode : D with *
Execution Controls Step Timer - 0.1 s - 1.0 s	None	Settings for SFC step timer. For CJ, right-click on the SFC editor to display the setting menu.
Execution controls Execution Controls 1 - Measures CPU Bus unit cycle	None	Specifies whether to measure the CPU Bus Unit cycle time on the CPU Unit. CJ does not support this function. Note: The execution time of cycle time is saved in A262 to 268.
Execution controls Execution Controls 1 - Don't detect Low Battery	CPU Settings Execute process -Do not detect Low Battery (Battery-free operation).	Specifies whether to turn on the specified bit when battery error is detected with the PLC or the memory card. There is no functional difference between CV/CVM1 and CJ.
Execution controls Execution Controls 1 - Run program when Bus Units initialize	Startup Execution Setting - Start running program when initializing Unit/Inner board recognition	Specifies whether to run program when the CPU Bus Units are initializing. There is no functional difference between CV/CVM1 and CJ.
Execution controls Execution Controls 1 - Error on power off interrupts	None	Specifies whether to handle the power off interruption as non-fatal error or not. The Auxiliary Area (AR) holds the power-ON time and power-OFF time with CJ. Consider using this clock information and the FAL instruction.
Execution controls Execution Controls 2 - Duplicate action error	None	Specifies whether to detect duplicate action error as a non-fatal error. No duplicate action error occurs on CJ, due to difference of operation specifications.
Execution controls Execution Controls 2 - Allow multiple JPM000 use	None	Specifies if two or more JMP0 instruction can be used or not. Two or more JMP0 instructions can be used by default with CJ.
Execution controls Execution Controls 2 - Run program on I/O verify error	None	Specifies if program is run at I/O verification error, or execution is suspended. CJ always runs program at I/O verification error. To stop the program with CJ, use the I/O verification error flag in AR Area.
Execution controls Execution Controls 2 - Startup trace enabled	None	Settings to automatically execute trace using pre-defined settings at power on or when operating mode is changed. CJ1 does not have this setting; consider creating a ladder program to execute this function. CJ2 executes trace at power on by default.
Execution controls Execution Controls 2 - Nest I/O interrupts	None	Specifies to suspend an interrupt task execution while other I/O interrupt task is being executed or execute one with higher priority first. With CJ, use MSKS instruction for this setting.
Execution controls Execution Controls 2 - Power OFF interrupt enabled.	Timings - Power Off Interrupt disabled	Specifies whether to execute power off interrupt program (task) or not. There is not functional difference between the CV/CVM1 and CJ.
Host Link Port Port Settings	Host Link Port Communication Setting and others	Settings for built-in host link port. There is no functional difference between CV/CVM1 and CJ, when the port is used for host link. When the CJ used NT Link, select NT Link for "Mode" in this setting. (For CV, the dip switches are used for this setting.)
I/O Refresh - Zero-Cross - Cyclic - Scheduled	None	Specifies the I/O refreshing method. Only cyclic refreshing and immediate refreshing with instructions are possible with CJ.

<p>Address Enable</p> <ul style="list-style-type: none"> ·Local Racks Set the first words for Racks 0 to 7. ·Group 1 and Group 2 Set the first words for RM0 to 3. ·Group 3, RT Slaves Set the first words for RM0-RT0 to RM7-RT7. ·I/O Slaves Set the first words for RM0 to 7. 	None	Specify the start address of a local rack. For CJ, start address can be set on the PLC I/O Table window. CJ does not support SYSMAC BUS/2.
<p>Timings</p> <ul style="list-style-type: none"> - Watch Cycle Time 	<p>Timings</p> <ul style="list-style-type: none"> - Watch cycle time 	Set the monitoring time for cycle time. There is no functional difference between the CV/CVM1 and CJ.
<p>Timings</p> <ul style="list-style-type: none"> - Power Off Interrupt 	<p>Timings</p> <ul style="list-style-type: none"> - Power OFF detection time 	Set the delay time to detect power interruption. There is no functional difference between the CV/CVM1 and CJ.
<p>Timings</p> <ul style="list-style-type: none"> - Cycle Time 	<p>Timings</p> <ul style="list-style-type: none"> - Constant Cycle Time 	Specifies the cycle time. The cycle time is set to the set time. There is no functional difference between the CV/CVM1 and CJ.
<p>Timings</p> <ul style="list-style-type: none"> - Scheduled Interrupt Interval 	<p>Timings</p> <ul style="list-style-type: none"> - Schedule Interrupt Interval 	Set the interval of scheduled interrupt. There is no functional difference between the CV/CVM1 and CJ.
<p>Timings</p> <ul style="list-style-type: none"> - CPU Bus Link Service 	None	Settings of whether to use CPU Bus Link function. CJ does not have this function. This function is used mainly to exchange data with BASIC Unit. Consider changing the BASIC program to CPU Unit and sharing data using the global variables.
<p>Hold</p> <ul style="list-style-type: none"> - Enable Hold Area 	None	Set the start address and end address of Hold area. Hold Area (Word H000 to 511) is fixed with CJ. The EM Area can be used for bit operation with CJ2, in the same way as HR Area.
<p>Hold</p> <ul style="list-style-type: none"> - CPU Set the hold status of Rack 0 to 7. ·Sys Bus/2 Set the hold status of RM 0 to 3. ·Sys Bus Set the hold status of RM 0 to 7. 	None	Set the holding status of each Rack. Holding status can not be set individually for each rack or RM with CJ.

Appendix D: Corresponding Input / Output Units

- Input Units

- (1) If the terminal block or connector is different, you have to change the wiring.
- (2) If the input specification is not same, check if there is no problem in operation.
- (3) If the number of circuits is different (or increased), wire and connect the terminals and each common terminals.
- (4) If the internal current consumption is different, check if enough power supply capacity is provided.
- (5) Functionally they are supported. Refer to the related manuals for the detailed specifications.

DC Input Units

CV/CVM1 Unit	Corresponding CJ-series Unit
Model: C500-ID112 Specification: 5 to 12 VDC, 16 mA Terminal block, 16 points,	Model: CJ1W-ID211 Specification: 24 VDC, 7 mA Terminal block, 16 points
Model: C500-ID213 Specification: 12 to 24 VDC, 10 mA Terminal block, 16 points,	Model: CJ1W-ID211 Specification: 24 VDC, 7 mA Terminal block, 16 points
Model: C500-ID215 Specification: 12 to 24 VDC, 10 mA Terminal block, 32 points,	Model: CJ1W-ID231/ID232 Specification: 24 VDC, 4.1 mA Connector, 32 points
Model: C500-ID218 Specification: 12 to 24 VDC, 10 mA Terminal block, 32 points	Model: CJ1W-ID231/ID232 Specification: 24 VDC, 4.1 mA Connector, 32 points
Model: C500-ID218CN Specification: 12 to 24 VDC, 10 mA Connector, 32 points	Model: CJ1W-ID231/ID232 Specification: 24 VDC, 4.1 mA Connector, 32 points
Model: C500-ID114 Specification: 12 VDC, 7 mA Connector, 64 points	Model: CJ1W-ID261/ID262 Specification: 24 VDC, 4.1 mA Connector, 64 points
Model: C500-ID212 Specification: 24 VDC, 10 mA Terminal block, 64 points dynamic	None * Consider changing to a static type (CJ1W-ID261/ID262).
Model: C500-ID219 Specification: 12 to 24 VDC, 7 mA Connector, 64 points	Model: CJ1W-ID261/(ID262) Specification: 24 VDC, 4.1 mA Connector, 64 points

TTL Input Units

CV/CVM1 Unit	Corresponding CJ-series Unit
Model: C500-ID501CN Specification: 5 VDC, 3.5 mA Connector, 32 points	None *Consider changing to the 24VDC input type (CJ1W-ID231) or the TTL I/O (CJ1W-MD563).

Interrupt Input Units

CV/CVM1 Unit	Corresponding CJ-series Unit
Model: C2000-ID216 Specification: 12 to 24 VDC, 13 mA Terminal block, 8 points (independent common)	Model: CJ1W-INT01 Specification: 24 VDC, 7 mA Terminal block, 16 points (16 points/common)

AC Input Units

CV/CVM1 Unit	Corresponding CJ-series Unit
Model: C500-IA121 Specification: 100 to 120 VAC, 10 mA Terminal block 16 points	Model: CJ1W-IA111 Specification: 100 to 120 VAC, 7 mA Terminal block, 16 points
Model: C500-IA222 Specification: 200 to 240 VAC, 10 mA Terminal block, 16 points	Model: CJ1W-IA201×2 Specification: 200 to 240 VAC, 9 mA Terminal block, 8 points
Model: C500-IA122 Specification: 100 to 120 VAC, 10 mA Terminal block. 32 points	Model: CJ1W-IA111×2 Specification: 100 to 120 VAC, 7 mA Terminal block, 16 points
Model: C500-IA223 Specification: 200 to 240 VAC, 10 mA Terminal block, 32 points	Model: CJ1W-IA201×4 Specification: 200 to 240 VAC, 9 mA Terminal block, 8 points

AC/DC Input Units

CV/CVM1 Unit	Corresponding CJ-series Unit
Model: C500-IM211 Specification: 12 to 24 VAC/VDC, 10 mA Terminal block, 16 points	Model: CJ1W-ID211 Specification: 24 VDC, 7 mA, Terminal block, 16 points *When you use the AC Input Unit, change wiring for DC Input Unit.
Model: C500-IM212 Specification: 12 to 24 VAC/VDC, 10 mA Terminal block, 32 points	Model: CJ1W-ID231/ID232 Specification: 24 VDC, 4.1 mA, Connector, 32 points *When you use the AC Input Unit, change wiring for DC Input Unit.

- Output Units

- (1) If the terminal block or connector is different, you have to change the wiring.
- (2) If the number of circuits is different (or increased), wire and connect the terminals and each common terminals.
- (3) If the output specification is different, check if there is no problem in operation.
- (4) When the used relays are different, you have to be aware that the relay service life might change depending on the usage. (Refer to the related manuals for details.)
- (5) If the internal current consumption is different, check if enough power supply capacity is provided.
- (6) If the voltage and current consumption of external power supply is different, check if enough power supply capacity is provided.
- (7) Functionally they are supported. Refer to the related manuals for the detailed specifications.

Relay Output Units

CV/CVM1 Unit	Corresponding CJ-series Unit
Model: C500-OC221 Specification: 250 VAC/24 VDC, 2 A Terminal block, 16 points	Model: CJ1W-OC211 Specification: 250 VAC/24 VDC, 2 A Terminal block, 16 points
Model: C500-OC223 Specification: 250 VAC/24 VDC, 2 A Terminal block, 16 points (independent common)	Model: CJ1W-OC201×2 Specification: 250 VAC/24 VDC, 2 A Terminal block, 8 points (independent common)
Model: C500-OC224 Specification: 250 VAC/24 VDC, 2 A Terminal block, 32 points	Model: CJ1W-OC211×2 Specification: 250 VAC/24 VDC, 2 A Terminal block, 16 points

Transistor Output Units

CV/CVM1 Unit	Corresponding CJ-series Unit
Model: C500-OD217 Specification: 12 to 24 VDC, 1 A Terminal block, 16 points	Model: CJ1W-OD211 Specification: 12 to 24 VDC, 0.5 A Terminal block, 16 points
Model: C500-OD219 Specification: 12 to 24 VDC, 2.1 A 16 points in which Terminal block	Model: CJ1W-OD211 Specification: 12 to 24 VDC, 0.5 A Terminal block, 16 points
Model: C500-OD411 Specification: 12 to 48 VDC, 1 A Terminal block, 16 points	Model: CJ1W-OD211 Specification: 12 to 24 VDC, 0.5 A Terminal block, 16 points
Model: C500-OD215 Specification: 24 VDC, 50 mA Terminal block, 16 points (independent common)	Model: CJ1W-OD211 Specification: 12 to 24 VDC, 0.5 A Terminal block, 16 points (8 points/common)
Model: C500-OD218 Specification: 12 to 24 VDC, 0.3 A Terminal block, 32 points	Model: CJ1W-OD231/OD233 Specification: 12 to 24 VDC, 0.5 A Connector, 32 points
Model: C500-OD414 Specification: 12 to 48 VDC, 0.3 A Terminal block, 32 points	Model: CJ1W-OD231/OD233 Specification: 12 to 24 VDC, 0.5 A Connector, 32 points
Model: C500-OD412 Specification: 12 to 48 VDC, 0.3 A Terminal block, 32 points	Model: CJ1W-OD231/OD233 Specification: 12 to 24 VDC, 0.5 A Connector, 32 points
Model: C500-OD415CN Specification: 12 to 48 VDC, 0.3 A Connector, 32 points	Model: CJ1W-OD231/OD233 Specification: 12 to 24 VDC, 0.5 A Connector, 32 points
Model: C500-OD212 Specification: 12 to 24 VDC, 0.3 A Terminal block, 32 points (PNP output)	Model: CJ1W-OD232 Specification: 12 to 24 VDC, 0.5 A Connector, 32 points (source output)
Model: C500-OD211 Specification: 24 VDC, 0.1 A Terminal block, 64 points, dynamic	None *Consider changing to the static type (CJ1W-OD261/OD263).
Model: C500-OD213 Specification: 24 VDC, 0.1 A Terminal block, 64 points	Model: CJ1W-OD261/OD263 Specification: 12 to 24 VDC, 0.3 A Connector, 64 points

TTL Output Unit

CV/CVM1 Unit	Corresponding CJ-series Unit
Model: C500-OD501CN Specification: 5 VDC, 35 mA Connector, 32 points	None - Consider changing to a 24-VDC input type (CJ1W-OD231/OD233) or a TTL I/O (CJ1W-MD563).

Triac Output Units

CV/CVM1 Unit	Corresponding CJ-series Unit
Model: C500-OA121 Specification: 132 VAC, 1 A Terminal block, 16 points	Model: CJ1W-OA201×2 Specification: 250 VAC, 0.6 A Terminal block, 8 points
Model: C500-OA222 Specification: 250 VAC, 1 A Terminal block, 16 points	Model: CJ1W-OA201×2 Specification: 250 VAC, 0.6 A Terminal block, 8 points
Model: C500-OA223 Specification: 250 VAC, 1 A Terminal block, 24 points	Model: CJ1W-OA201×3 Specification: 250 VAC, 0.6 A Terminal block, 8 points
Model: C500-OA225 Specification: 250 VAC, 1 A Terminal block, 32 points	Model: CJ1W-OA201×4 Specification: 250 VAC, 0.6 A Terminal block, 8 points
Model: C500-OA226 Specification: 250 VAC, 1.2 A Terminal block, 16 points	Model: CJ1W-OA201×2 Specification: 250 VAC, 0.6 A Terminal block, 8 points

- Input/Output Units

- (1) If the terminal block or connector is different, you have to change the wiring.
- (2) If the input or output specification is different, check if there is no problem in operation.
- (3) If the number of circuits is different (or increased), wire and connect the terminals and each common terminals.
- (4) If the internal current consumption is different, check if enough power supply capacity is provided.
- (5) If the voltage and current consumption of external power supply is different, check if enough power supply capacity is provided.
- (6) Functionally they are supported. Refer to the related manuals for the detailed specifications.

DC Input/Transistor Output Unit

CV/CVM1 Unit	Corresponding CJ-series Unit
Model: C500-MD211CN Specification: 12 to 24 VDC Input, 10 mA 12 to 24 VDC Output, 0.3 A Connector, 16 points/16 points	Model: CJ1W-MD231 Specification: 24 VDC Input, 7 mA 12 to 24 VDC Output, 0.5A Connector, 16 points/16 points

OMRON Corporation Industrial Automation Company

Tokyo, JAPAN

Contact: www.ia.omron.com

Regional Headquarters

OMRON EUROPE B.V.

Wegalaan 67-69-2132 JD Hoofddorp
The Netherlands

Tel: (31)2356-81-300/Fax: (31)2356-81-388

OMRON ELECTRONICS LLC

One Commerce Drive Schaumburg,
IL 60173-5302 U.S.A.

Tel: (1) 847-843-7900/Fax: (1) 847-843-7787

OMRON ASIA PACIFIC PTE. LTD.

No. 438A Alexandra Road # 05-05/08 (Lobby 2),
Alexandra Technopark,
Singapore 119967

Tel: (65) 6835-3011/Fax: (65) 6835-2711

OMRON (CHINA) CO., LTD.

Room 2211, Bank of China Tower,
200 Yin Cheng Zhong Road,
PuDong New Area, Shanghai, 200120, China

Tel: (86) 21-5037-2222/Fax: (86) 21-5037-2200

Authorized Distributor:

© OMRON Corporation 2011 All Rights Reserved.
In the interest of product improvement,
specifications are subject to change without notice.

Cat. No. P077-E1-01

Printed in Japan
0911(-)