

Wall mounted receptacle with TwinCONTACT - Part no. 421

- screwless spring terminals
- suitable for through wiring
- internal fixing
- enclosure base can be turned 180°
- receptacles are designed for adding an auxiliary contact switch

Technical information	
Ampere	32 A
Poles	4 p
Voltage	400V
Earth position	6 h
Hertz	50-60 Hz
Connection technology	Screwless - TwinCONTACT
Contact	standard
Protection type	IP 44

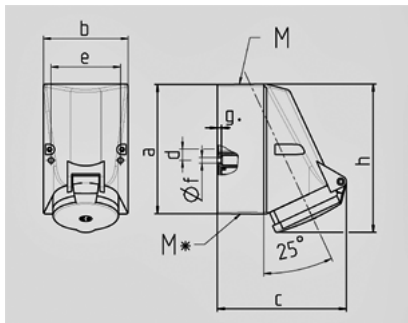

Drawing 1 MB 43	Amp. Poles	16		32		
		4	5	3	4	5
Dim. in mm	a	128	128	128	128	128
	b	84	84	84	84	84
	c	122	124	136	136	138
	d	11	11	11	11	11
	e	68	68	68	68	68
	f	5,3	5,3	5,3	5,3	5,3
	g	4	4	4	4	4
	h	144	145	158	158	160
	M	25	25	32	32	32
	M*	2x25 (blind) to be cut out		2x25 (blind) to be cut out		
	Max. cable diam. (mm)	18	18	18/25	18/25	18/25
	Terminal for cond. cross section (mm²) min.-max.	1,5	1,5	2,5	2,5	2,5
		-4	-4	-10	-10	-10