

Wall mounted receptacle with TwinCONTACT - Part no. 31

- screwless spring terminals
- external fixing

Technical information

Ampere	16 A
Poles	5 p
Voltage	400V
Earth position	6 h
Hertz	50-60 Hz
Connection technology	Screwless - TwinCONTACT
Contact	standard
Protection type	IP 44

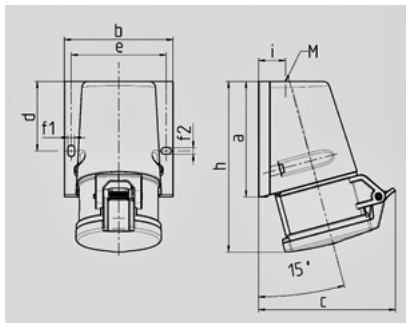

Drawing 1 MB 463	Amp. Poles	16			32		
		3	4	5	3	4	5
Dim. in mm	a	95	93	92,5	102	102	102
	b	73,5	87,5	87,5	94	94	94
	c	93	107,5	110	115,5	115,5	119,5
	d	55,5	55,5	55,5	62	62	62
	e	61	76	76	84	84	84
	f1	5,3	5,3	5,3	5,1	5,1	5,1
	f2	5,3	5,3	5,3	5,1	5,1	5,1
	h	139	139	136,5	160	160	156,5
	i	19,8	21,5	21,5	26,5	26,5	26,5
	M	M20x	M25x	M25x	M25x	M32x	M32x
	Terminal for cond. cross section (mm²) min.-max.	1,5	1,5	1,5	1,5	1,5	1,5
		1,5	1,5	1,5	2,5	2,5	2,5
		-4	-4	-4	-6	-6	-6