

Wall mounted receptacle with TwinCONTACT - Part no. 1725

- screwless spring terminals
- suitable for through wiring
- internal fixing
- 4 p and 5 p receptacles the enclosure can be turned 180°

Technical information

Ampere	16 A
Poles	4 p
Voltage	500V
Earth position	7 h
Hertz	50-60 Hz
Connection technology	Screwless - TwinCONTACT
Contact	standard
Protection type	IP 44

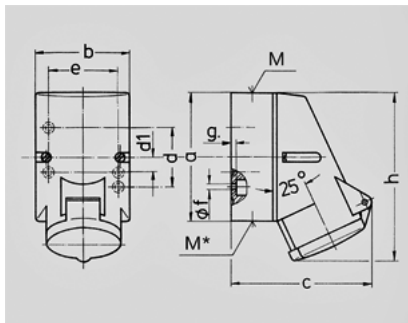

Drawing 1 MB 209	Amp. Poles	16		
		3	4	5
Dim. in mm	a	87	100	100
	b	64	75	75
	c	99	110	113
	d	40	-	-
	d1	-	11	11
	e	50	59	59
	f	4,5	5	5
	g	4	4	4
	h	115	125	128
	M	20	20	20
	M*	M20 (blind) to be cut out		
	Max. cable diam. (mm)	15	15	15
	Terminal for cond. cross section (mm²) min.-max.	1,5	1,5	1,5
		-4	-4	-4